



DUAL 4-INPUT MULTIPLEXER WITH 3-STATE OUTPUTS

The LSTTL/MSI SN54/74LS253 is a Dual 4-Input Multiplexer with 3-state outputs. It can select two bits of data from four sources using common select inputs. The outputs may be individually switched to a high impedance state with a HIGH on the respective Output Enable (E_0) inputs, allowing the outputs to interface directly with bus oriented systems. It is fabricated with the Schottky barrier diode process for high speed and is completely compatible with all Motorola TTL families.

- Schottky Process for High Speed
- Multifunction Capability
- Non-Inverting 3-State Outputs
- Input Clamp Diodes Limit High Speed Termination Effects

CONNECTION DIAGRAM DIP (TOP VIEW)

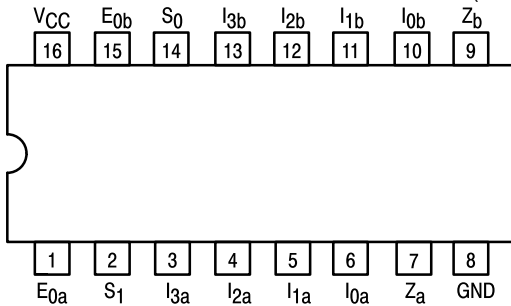

NOTE:
The Flatpak version has the same pinouts (Connection Diagram) as the Dual In-Line Package.

PIN NAMES

- S_0, S_1 Common Select Inputs
- Multiplexer A**
- E_{0a} Output Enable (Active LOW) Input
- $I_{0a}-I_{3a}$ Multiplexer Inputs
- Z_a Multiplexer Output (Note b)
- Multiplexer B**
- E_{0b} Output Enable (Active LOW) Input
- $I_{0b}-I_{3b}$ Multiplexer Inputs
- Z_b Multiplexer Output (Note b)

LOADING (Note a)

	HIGH	LOW
S_0, S_1	0.5 U.L.	0.25 U.L.
E_{0a}	0.5 U.L.	0.25 U.L.
$I_{0a}-I_{3a}$	0.5 U.L.	0.25 U.L.
Z_a	65 (25) U.L.	15 (7.5) U.L.
E_{0b}	0.5 U.L.	0.25 U.L.
$I_{0b}-I_{3b}$	0.5 U.L.	0.25 U.L.
Z_b	65 (25) U.L.	15 (7.5) U.L.

NOTES:

- a) 1 TTL Unit Load (U.L.) = 40 μ A HIGH/1.6 mA LOW.
- b) The Output LOW drive factor is 7.5 U.L. for Military (54) and 15 U.L. for Commercial (74) Temperature Ranges. The Output HIGH drive factor is 25 U.L. for Military (54) and 65 U.L. for Commercial (74) Temperature Ranges.

SN54/74LS253

DUAL 4-INPUT MULTIPLEXER WITH 3-STATE OUTPUTS LOW POWER SCHOTTKY

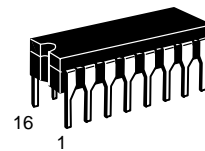

J SUFFIX
CERAMIC
CASE 620-09

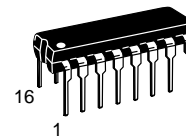

N SUFFIX
PLASTIC
CASE 648-08

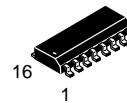

D SUFFIX
SOIC
CASE 751B-03

ORDERING INFORMATION

- SN54LSXXXJ Ceramic
SN74LSXXXN Plastic
SN74LSXXXD SOIC

LOGIC SYMBOL

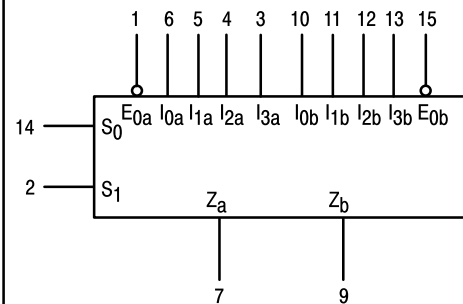

V_{CC} = PIN 16
 GND = PIN 8

SN54/74LS253

LOGIC DIAGRAM

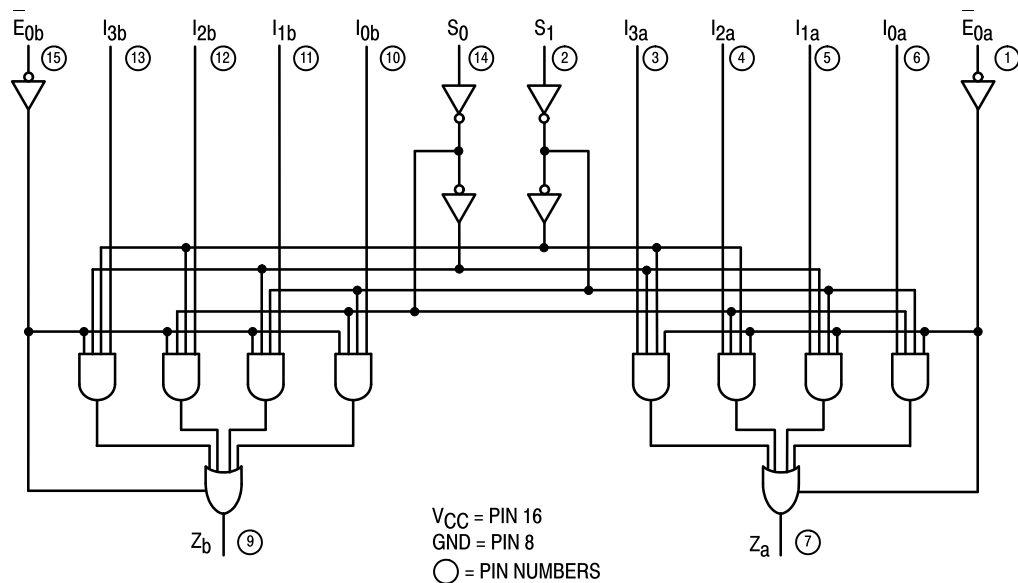

FUNCTIONAL DESCRIPTION

The LS253 contains two identical 4-Input Multiplexers with 3-state outputs. They select two bits from four sources selected by common select inputs (S_0 , S_1). The 4-input multiplexers have individual Output Enable (E_{0a} , E_{0b}) inputs which when HIGH, forces the outputs to a high impedance (high Z) state.

The LS253 is the logic implementation of a 2-pole, 4-position switch, where the position of the switch is determined by the logic levels supplied to the two select inputs. The logic equations for the outputs are shown below:

$$Z_a = \bar{E}_{0a} \cdot (I_{0a} \cdot \bar{S}_1 \cdot \bar{S}_0 + I_{1a} \cdot \bar{S}_1 \cdot S_0 + I_{2a} \cdot S_1 \cdot \bar{S}_0 + I_{3a} \cdot S_1 \cdot S_0)$$

$$Z_b = E_{0b} \cdot (I_{0b} \cdot \bar{S}_1 \cdot \bar{S}_0 + I_{1b} \cdot \bar{S}_1 \cdot S_0 + I_{2b} \cdot S_1 \cdot \bar{S}_0 + I_{3b} \cdot S_1 \cdot S_0)$$

If the outputs of 3-state devices are tied together, all but one device must be in the high impedance state to avoid high currents that would exceed the maximum ratings. Designers should ensure that Output Enable signals to 3-state devices whose outputs are tied together are designed so that there is no overlap.

TRUTH TABLE

SELECT INPUTS		DATA INPUTS				OUTPUT ENABLE	OUTPUT
S_0	S_1	I_0	I_1	I_2	I_3	E_0	Z
X	X	X	X	X	X	H	(Z)
L	L	L	X	X	X	L	L
L	L	H	X	X	X	L	H
H	L	X	L	X	X	L	L
H	L	X	H	X	X	L	H
L	H	X	X	L	X	L	L
L	H	X	X	H	X	L	H
H	H	X	X	X	L	L	L
H	H	X	X	X	H	L	H

H = HIGH Level

L = LOW Level

X = Irrelevant

(Z) = High Impedance (off)

Address inputs S_0 and S_1 are common to both sections.

SN54/74LS253

GUARANTEED OPERATING RANGES

Symbol	Parameter		Min	Typ	Max	Unit
V _{CC}	Supply Voltage	54 74	4.5 4.75	5.0 5.0	5.5 5.25	V
T _A	Operating Ambient Temperature Range	54 74	-55 0	25 25	125 70	°C
I _{OH}	Output Current — High	54 74			-1.0 -2.6	mA
I _{OL}	Output Current — Low	54 74			12 24	mA

DC CHARACTERISTICS OVER OPERATING TEMPERATURE RANGE (unless otherwise specified)

Symbol	Parameter	Limits			Unit	Test Conditions	
		Min	Typ	Max			
V _{IH}	Input HIGH Voltage	2.0			V	Guaranteed Input HIGH Voltage for All Inputs	
V _{IL}	Input LOW Voltage	54		0.7	V	Guaranteed Input LOW Voltage for All Inputs	
		74		0.8			
V _{IK}	Input Clamp Diode Voltage		-0.65	-1.5	V	V _{CC} = MIN, I _{IN} = -18 mA	
V _{OH}	Output HIGH Voltage	54	2.4	3.4	V	V _{CC} = MIN, I _{OH} = MAX, V _{IN} = V _{IH} or V _{IL} per Truth Table	
		74	2.4	3.1	V		
V _{OL}	Output LOW Voltage	54, 74		0.25	0.4	V	I _{OL} = 12 mA V _{CC} = V _{CC} MIN, V _{IN} = V _{IL} or V _{IH} per Truth Table
		74		0.35	0.5	V	
I _{OZH}	Output Off Current HIGH			20	μA	V _{CC} = MAX, V _{OUT} = 2.7 V	
I _{OZL}	Output Off Current LOW			-20	μA	V _{CC} = MAX, V _{OUT} = 0.4 V	
I _{IH}	Input HIGH Current			20	μA	V _{CC} = MAX, V _{IN} = 2.7 V	
				0.1	mA	V _{CC} = MAX, V _{IN} = 7.0 V	
I _{IL}	Input LOW Current			-0.4	mA	V _{CC} = MAX, V _{IN} = 0.4 V	
I _{OS}	Short Circuit Current (Note 1)	-30		-130	mA	V _{CC} = MAX	
I _{CC}	Power Supply Current			12	mA	V _{CC} = MAX, V _E = 0 V	
				14	mA	V _{CC} = MAX, V _E = 4.5 V	

Note 1: Not more than one output should be shorted at a time, nor for more than 1 second.

AC CHARACTERISTICS (T_A = 25°C, V_{CC} = 5.0 V) See SN54LS251 for Waveforms

Symbol	Parameter	Limits			Unit	Test Conditions
		Min	Typ	Max		
t _{PLH} t _{PHL}	Propagation Delay, Data to Output		17 13	25 20	ns	Figure 1
t _{PLH} t _{PHL}	Propagation Delay, Select to Output		30 21	45 32	ns	Figure 1
t _{PZH} t _{PZL}	Output Enable Time		15 15	28 23	ns	Figures 4, 5
t _{PHZ} t _{PLZ}	Output Disable Time		27 18	41 27	ns	Figures 3, 5

C_L = 45 pF,
R_L = 667 Ω

C_L = 5.0 pF,
R_L = 667 Ω

**Case 751B-03 D Suffix
16-Pin Plastic
SO-16**



- NOTES:
1. DIMENSIONING AND TOLERANCING PER ANSI Y14.5M, 1982.
 2. CONTROLLING DIMENSION: MILLIMETER.
 3. DIMENSION A AND B DO NOT INCLUDE MOLD PROTRUSION.
 4. MAXIMUM MOLD PROTRUSION 0.15 (0.006) PER SIDE.
 5. 751B-01 IS OBSOLETE, NEW STANDARD 751B-03.

DIM	MILLIMETERS		INCHES	
	MIN	MAX	MIN	MAX
A	9.80	10.00	0.386	0.393
B	3.80	4.00	0.150	0.157
C	1.35	1.75	0.054	0.068
D	0.35	0.49	0.014	0.019
F	0.40	1.25	0.016	0.049
G	1.27 BSC		0.050 BSC	
J	0.19	0.25	0.008	0.009
K	0.10	0.25	0.004	0.009
M	0°	7°	0°	7°
P	5.80	6.20	0.229	0.244
R	0.25	0.50	0.010	0.019

**Case 648-08 N Suffix
16-Pin Plastic**



- NOTES:
1. DIMENSIONING AND TOLERANCING PER ANSI Y14.5M, 1982.
 2. CONTROLLING DIMENSION: INCH.
 3. DIMENSION "L" TO CENTER OF LEADS WHEN FORMED PARALLEL.
 4. DIMENSION "B" DOES NOT INCLUDE MOLD FLASH.
 5. ROUNDED CORNERS OPTIONAL.
 6. 648-01 THRU -07 OBSOLETE, NEW STANDARD 648-08.

DIM	MILLIMETERS		INCHES	
	MIN	MAX	MIN	MAX
A	18.80	19.55	0.740	0.770
B	6.35	6.85	0.250	0.270
C	3.69	4.44	0.145	0.175
D	0.39	0.53	0.015	0.021
F	1.02	1.77	0.040	0.070
G	2.54 BSC		0.100 BSC	
H	1.27 BSC		0.050 BSC	
J	0.21	0.38	0.008	0.015
K	2.80	3.30	0.110	0.130
L	7.50	7.74	0.295	0.305
M	0°	10°	0°	10°
S	0.51	1.01	0.020	0.040

**Case 620-09 J Suffix
16-Pin Ceramic Dual In-Line**

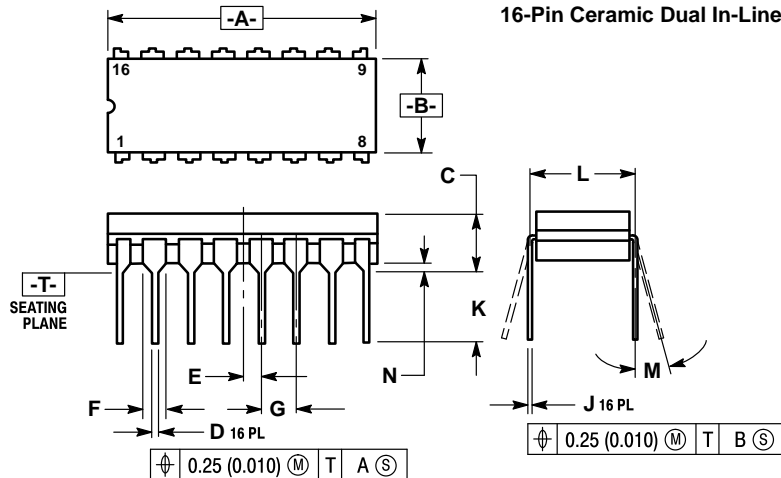

- NOTES:
1. DIMENSIONING AND TOLERANCING PER ANSI Y14.5M, 1982.
 2. CONTROLLING DIMENSION: INCH.
 3. DIMENSION L TO CENTER OF LEAD WHEN FORMED PARALLEL.
 4. DIM F MAY NARROW TO 0.76 (0.030) WHERE THE LEAD ENTERS THE CERAMIC BODY.
 5. 620-01 THRU -08 OBSOLETE, NEW STANDARD 620-09.

DIM	MILLIMETERS		INCHES	
	MIN	MAX	MIN	MAX
A	19.05	19.55	0.750	0.770
B	6.10	7.36	0.240	0.290
C	—	4.19	—	0.165
D	0.39	0.53	0.015	0.021
E	1.27 BSC		0.050 BSC	
F	1.40	1.77	0.055	0.070
G	2.54 BSC		0.100 BSC	
J	0.23	0.27	0.009	0.011
K	—	5.08	—	0.200
L	7.62 BSC		0.300 BSC	
M	0°	15°	0°	15°
N	0.39	0.88	0.015	0.035

Motorola reserves the right to make changes without further notice to any products herein. Motorola makes no warranty, representation or guarantee regarding the suitability of its products for any particular purpose, nor does Motorola assume any liability arising out of the application or use of any product or circuit, and specifically disclaims any and all liability, including without limitation consequential or incidental damages. "Typical" parameters can and do vary in different applications. All operating parameters, including "Typicals" must be validated for each customer application by customer's technical experts. Motorola does not convey any license under its patent rights nor the rights of others. Motorola products are not designed, intended, or authorized for use as components in systems intended for surgical implant into the body, or other applications intended to support or sustain life, or for any other application in which the failure of the Motorola product could create a situation where personal injury or death may occur. Should Buyer purchase or use Motorola products for any such unintended or unauthorized application, Buyer shall indemnify and hold Motorola and its officers, employees, subsidiaries, affiliates, and distributors harmless against all claims, costs, damages, and expenses, and reasonable attorney fees arising out of, directly or indirectly, any claim of personal injury or death associated with such unintended or unauthorized use, even if such claim alleges that Motorola was negligent regarding the design or manufacture of the part. Motorola and  are registered trademarks of Motorola, Inc. Motorola, Inc. is an Equal Opportunity/Affirmative Action Employer.

Literature Distribution Centers:

USA: Motorola Literature Distribution; P.O. Box 20912; Phoenix, Arizona 85036.

EUROPE: Motorola Ltd.; European Literature Centre; 88 Tanners Drive, Blakelands, Milton Keynes, MK14 5BP, England.

JAPAN: Nippon Motorola Ltd.; 4-32-1, Nishi-Gotanda, Shinagawa-ku, Tokyo 141, Japan.

ASIA PACIFIC: Motorola Semiconductors H.K. Ltd.; Silicon Harbour Center, No. 2 Dai King Street, Tai Po Industrial Estate, Tai Po, N.T., Hong Kong.



This datasheet has been download from:

www.datasheetcatalog.com

Datasheets for electronics components.