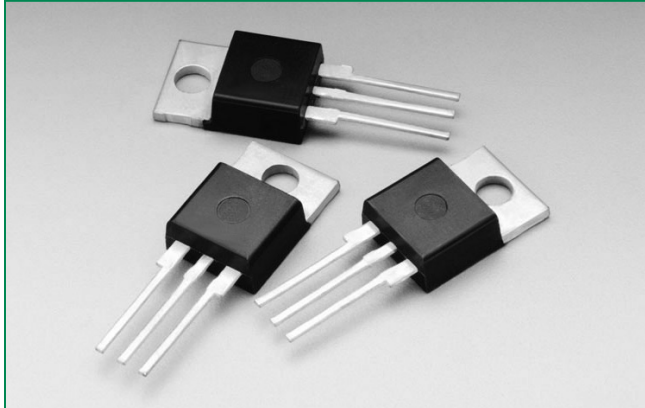



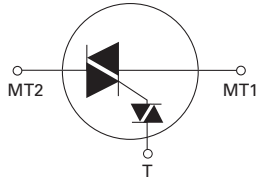
**RoHS QxxxxLTx Series**



**Agency Approval**

Agency	Agency File Number
	L Package : E71639

**Schematic Symbol**



**Main Features**

Symbol	Value	Unit
$I_{T(RMS)}$	4 to 15	A
$V_{DRM} / V_{RRM}$	400 to 600	V
DIAC $V_{BO}$	33 to 43	V

**Description**

The Quadrac is an internally triggered Triac designed for AC switching and phase control applications. It is a Triac and DIAC in a single package, which saves user expense by eliminating the need for separate Triac and DIAC components.

Standard type devices normally operate in Quadrants I & III triggered from AC line.

Alternistor type Quadracs are used in circuits requiring high dv/dt capability.

**Features & Benefits**

- RoHS Compliant
- Glass – passivated junctions
- Voltage capability up to 600 V
- Surge capability up to 200 A

**Applications**

Excellent for AC switching and phase control applications such as lighting and heating. Typical applications are AC solid-state switches, light dimmers, power tools, home/ brown goods and white goods appliances.

Alternistor Quadracs (no snubber required) are used in applications with extremely inductive loads requiring highest commutation performance.

Internally constructed isolated package is offered for ease of heat sinking with highest isolation voltage.

4/6/8/10/15 A QUADRACS

**Absolute Maximum Ratings**

Symbol	Parameter	Value					Unit	
		Qxx04LT	Qxx06LT / Qxx06LTH	Qxx08LT / Qxx08LTH	Qxx10LT / Qxx10LTH	Qxx15LT / Qxx15LTH		
$I_{T(RMS)}$	RMS forward current	Qxx04LT: $T_C = 95^\circ\text{C}$ Qxx06LT/Qxx08LT/Qxx10LT: $T_C = 90^\circ\text{C}$ Qxx15LT: $T_C = 80^\circ\text{C}$					A	
$I_{TSM}$	Peak non-repetitive surge current	single half cycle; $f = 50\text{Hz}$ ; $T_J$ (initial) = $25^\circ\text{C}$	46	65	83	100	167	A
		single half cycle; $f = 60\text{Hz}$ ; $T_J$ (initial) = $25^\circ\text{C}$	55	80	100	120	200	
$I^2t$	$I^2t$ value for fusing	$t_p = 8.3\text{ms}$					$\text{A}^2\text{s}$	
$di/dt$	Critical rate-of-rise of on-state current	$f = 60\text{Hz}$ ; $T_J = 125^\circ\text{C}$					$\text{A}/\mu\text{s}$	
$I_{GM}$	Peak gate current	$T_J = 125^\circ\text{C}$					A	
$T_{stg}$	Storage temperature range	-40 to 150					$^\circ\text{C}$	
$T_J$	Operating junction temperature range	-40 to 125					$^\circ\text{C}$	

Note: xx = voltage

**Electrical Characteristics ( $T_J = 25^\circ\text{C}$ , unless otherwise specified) – Standard Quadrac**

Symbol	Test Conditions		Value					Unit	
			Qxx04LT	Qxx06LT	Qxx08LT	Qxx10LT	Qxx15LT		
$I_H$	$I_T = 200\text{mA}$ (initial)	MAX.	40	50	60	60	70	mA	
$dv/dt$	$V_D = V_{DRM}$ ; gate open; $T_J = 100^\circ\text{C}$	MIN.	400V	75	150	175	200	300	$\text{V}/\mu\text{s}$
			600V	50	125	150	175	200	
	$V_D = V_{DRM}$ ; gate open; $T_J = 125^\circ\text{C}$	MIN.	400V	50	100	120	150	200	
			600V	50	85	100	120	150	
$dv/dt(c)$	$di/dt(c) = 0.54 \times I_{T(rms)} / \text{ms}$ ; $T_J = 125^\circ\text{C}$	MIN.	3	4				$\text{V}/\mu\text{s}$	
$t_{gt}$	(note 1)	TYP.	3				$\mu\text{s}$		

(1) Reference test circuit in figure 10 and waveform in figure 11;  $C_T = 0.1\mu\text{F}$  with  $0.1\mu\text{s}$  rise time.

Note: xx = voltage

**Electrical Characteristics ( $T_J = 25^\circ\text{C}$ , unless otherwise specified) – Alternistor Quadrac**

Symbol	Test Conditions		Value				Unit	
			Qxx06LTH	Qxx08LTH	Qxx10LTH	Qxx15LTH		
$I_H$	$I_T = 20\text{mA}$ (initial)	MAX.	50	50	60	70	mA	
$dv/dt$	$V_D = V_{DRM}$ ; gate open; $T_J = 100^\circ\text{C}$	MIN.	400V	575		925		$\text{V}/\mu\text{s}$
			600V	425		775		
	$V_D = V_{DRM}$ ; gate open; $T_J = 125^\circ\text{C}$	MIN.	400V	450		700		
			600V	350		600		
$dv/dt(c)$	$di/dt(c) = 0.54 \times I_{T(rms)} / \text{ms}$ ; $T_J = 125^\circ\text{C}$	MIN.	25		30		$\text{V}/\mu\text{s}$	
$t_{gt}$	(note 1)	TYP.	3				$\mu\text{s}$	

(1) Reference test circuit in figure 10 and waveform in figure 11;  $C_T = 0.1\mu\text{F}$  with  $0.1\mu\text{s}$  rise time.

Note: xx = voltage

**Trigger DIAC Specifications**

Symbol	Test Conditions		Value	Unit
$\Delta V_{BO}$	Breakover Voltage Symmetry	MAX.	3	V
$V_{BO}$	Breakover Voltage, forward and reverse	MIN.	33	V
		MAX.	43	
$[\Delta V_{\pm}]$	Dynamic Breakback Voltage, forward and reverse (note 1)	MIN.	5	V
$I_{BO}$	Peak Breakover Current	MAX.	25	$\mu A$
$C_T$	Trigger Firing Capacitance	MAX.	0.1	$\mu F$

(1) Reference test circuit in figure 10 and waveform in figure 11.

**Static Characteristics**

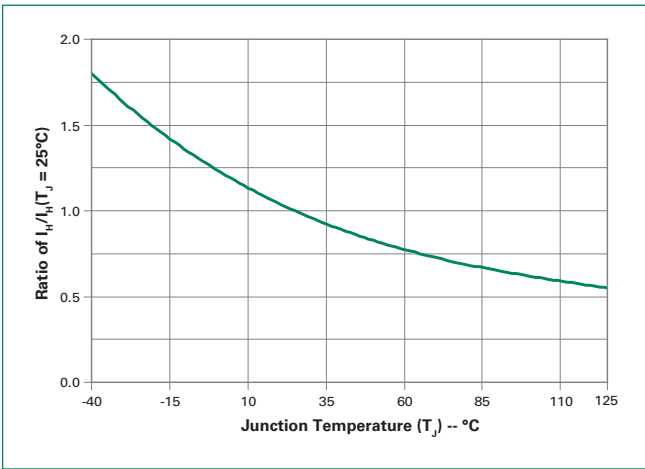
Symbol	Test Conditions		Value	Unit	
$V_{TM}$	$I_T = 1.41 \times I_{T(rms)}$ A; $t_p = 380\mu s$	MAX.	1.6	V	
$I_{DRM} / I_{RRM}$	$V_{DRM} / V_{RRM}$	$T_J = 25^\circ C$	MAX.	10	$\mu A$
		$T_J = 100^\circ C$		500	
		$T_J = 125^\circ C$		2000	

**Thermal Resistances**

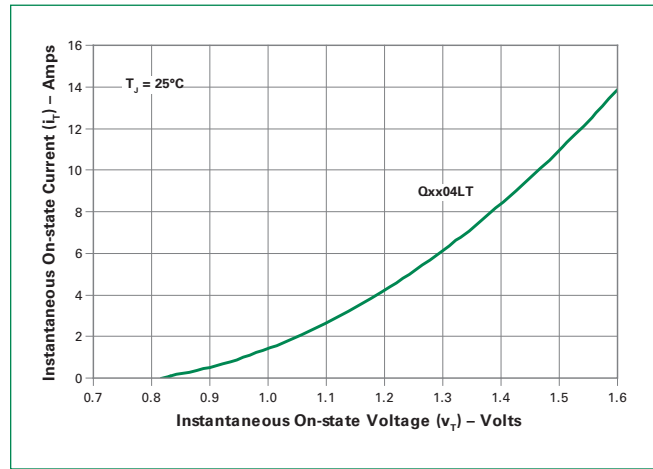
Symbol	Parameter		Value	Unit
$R_{\theta(J-C)}$	Junction to case (AC)	Qxx04LT	3.6	$^\circ C/W$
		Qxx06LT / Qxx06LTH	3.3	
		Qxx08LT / Qxx08LTH	2.8	
		Qxx10LT / Qxx10LTH	2.6	
		Qxx15LT / Qxx15LTH	2.1	
$R_{\theta(J-A)}$	Junction to ambient		50	$^\circ C/W$

Note : xx = voltage

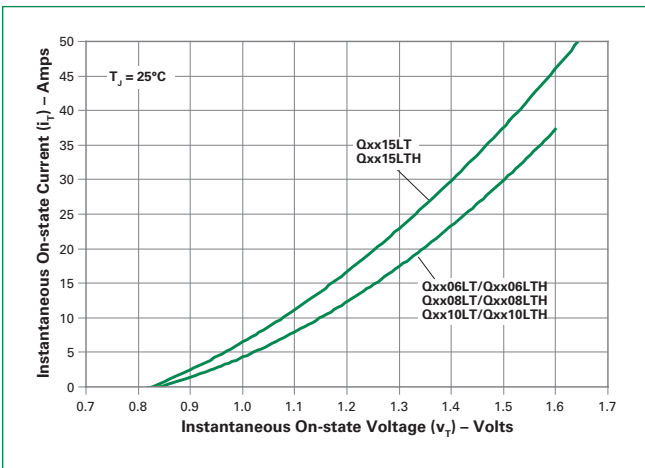
**Figure 1: Normalized DC Holding Current vs. Junction Temperature**



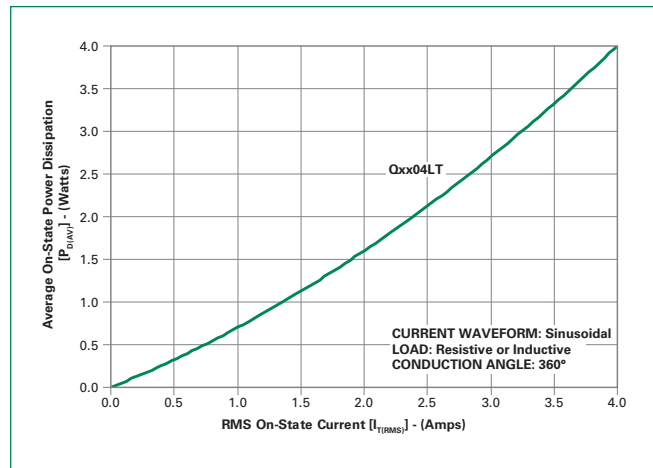
**Figure 2: On-State Current vs. On-State Voltage (Typical) (4A)**



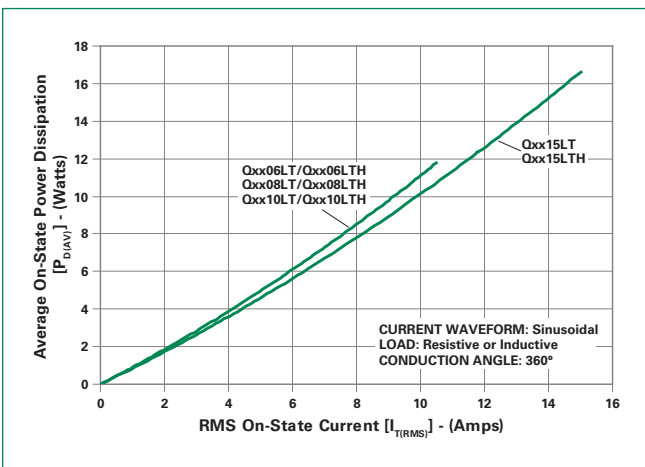
**Figure 3: On-State Current vs. On-State Voltage (Typical) (6A to 15A)**



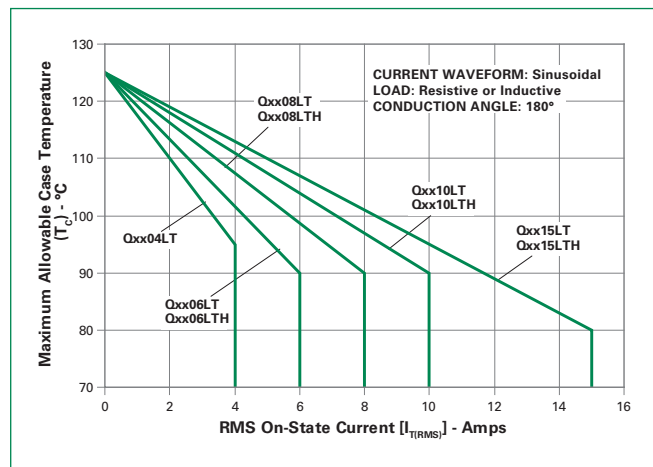
**Figure 4: Power Dissipation vs. RMS On-State Current (Typical) (4A)**



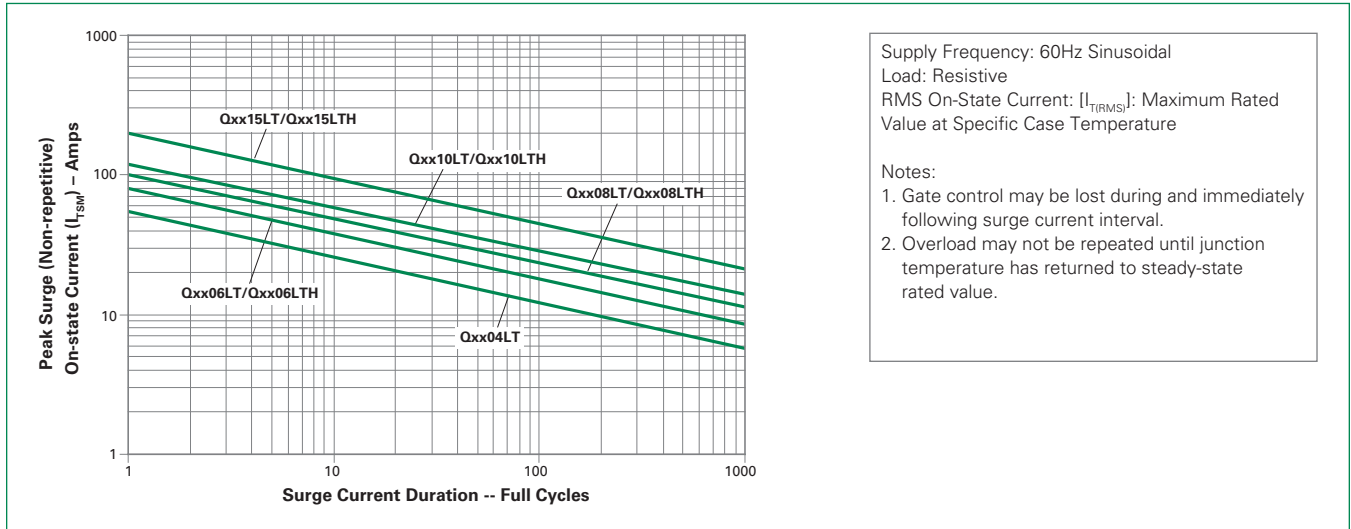
**Figure 5: Power Dissipation vs. RMS On-State Current (Typical) (6A to 15A)**



**Figure 6: Maximum Allowable Case Temperature vs. RMS On-State Current**

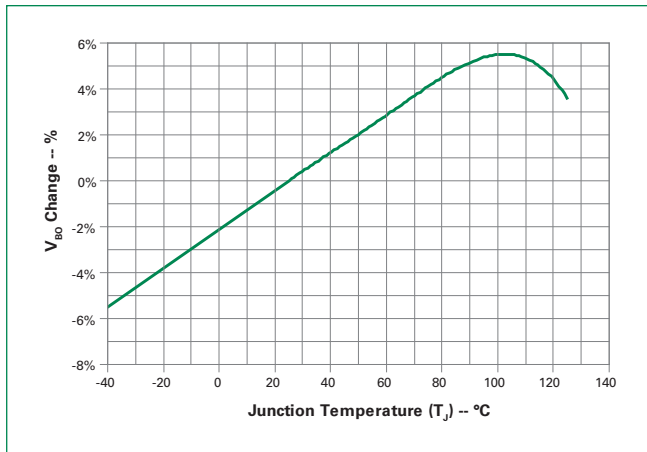


**Figure 7: Surge Peak On-State Current vs. Number of Cycles**

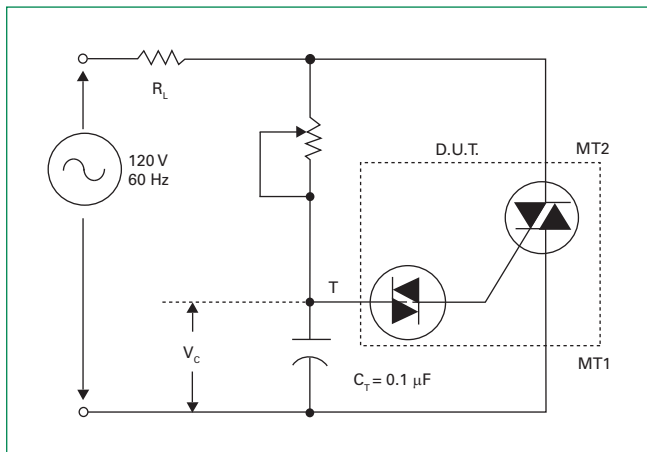


Note: xx = voltage

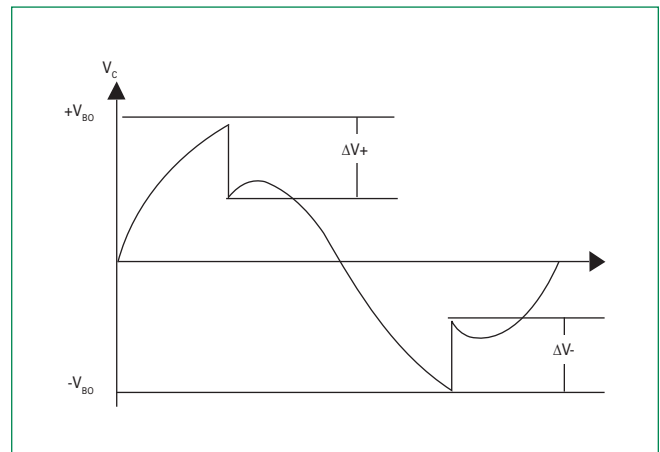
**Figure 8: DIAC  $V_{BO}$  Change vs. Junction Temperature**



**Figure 9: Test Circuit**

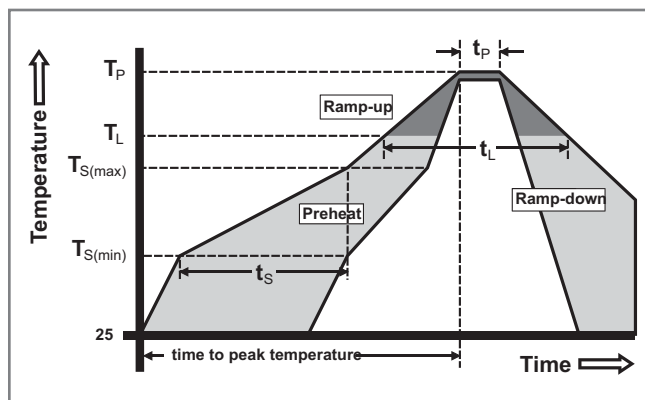


**Figure 10: Test Circuit Waveform**



### Soldering Parameters

Reflow Condition		Pb – Free assembly
Pre Heat	- Temperature Min ( $T_{s(min)}$ )	150°C
	- Temperature Max ( $T_{s(max)}$ )	200°C
	- Time (min to max) ( $t_s$ )	60 – 190 secs
Average ramp up rate (Liquidus Temp ( $T_L$ ) to peak)		5°C/second max
$T_{s(max)}$ to $T_L$ - Ramp-up Rate		5°C/second max
Reflow	- Temperature ( $T_L$ ) (Liquidus)	217°C
	- Temperature ( $t_L$ )	60 – 150 seconds
Peak Temperature ( $T_p$ )		260°C <sup>+0/-5</sup>
Time within 5°C of actual peak Temperature ( $t_p$ )		20 – 40 seconds
Ramp-down Rate		5°C/second max
Time 25°C to peak Temperature ( $T_p$ )		8 minutes Max.
Do not exceed		280°C



### Physical Specifications

<b>Terminal Finish</b>	1005 Matte Tin-plated
<b>Body Material</b>	UL Recognized epoxy meeting flammability classification 94-0
<b>Lead Material</b>	Copper Alloy

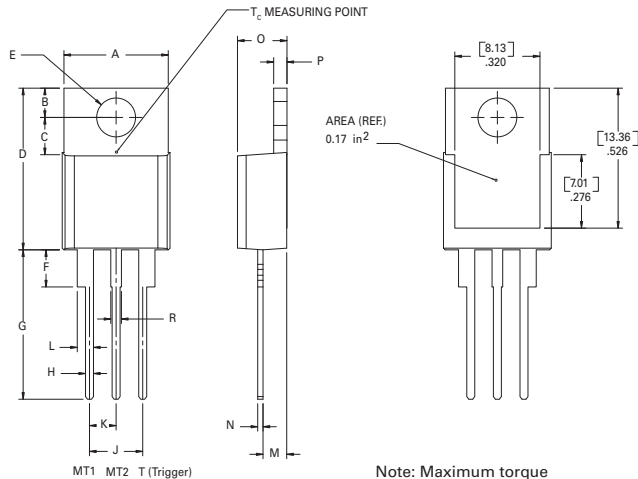
### Design Considerations

Careful selection of the correct device for the application's operating parameters and environment will go a long way toward extending the operating life of the Thyristor. Good design practice should limit the maximum continuous current through the main terminals to 75% of the device rating. Other ways to ensure long life for a power discrete semiconductor are proper heat sinking and selection of voltage ratings for worst case conditions. Overheating, overvoltage (including dv/dt), and surge currents are the main killers of semiconductors. Correct mounting, soldering, and forming of the leads also help protect against component damage.

### Environmental Specifications

Test	Specifications and Conditions
<b>High Temperature Voltage Blocking</b>	MIL-STD-750: Method 1040, Condition A Rated $V_{DRM}$ (VAC-peak), 125°C, 1008 hours
<b>Temperature Cycling</b>	MIL-STD-750: Method 1051 -40°C to 150°C, 15-minute dwell, 100 cycles
<b>Biased Temperature &amp; Humidity</b>	EIA/JEDEC: JESD22-A101 320VDC, 85°C, 85%RH, 1008 hours
<b>High Temp Storage</b>	MIL-STD-750: Method 1031 150°C, 1008 hours
<b>Low-Temp Storage</b>	-40°C, 1008 hours
<b>Thermal Shock</b>	MIL-STD-750: Method 1056 0°C to 100°C, 5-minute dwell, 10-second transfer, 10 cycles
<b>Autoclave (Pressure Cooker Test)</b>	EIA/JEDEC: JESD22-A102 121°C, 100%RH, 2atm, 168 hours
<b>Resistance to Solder Heat</b>	MIL-STD-750: Method 2031 260°C, 10 seconds
<b>Solderability</b>	ANSI/J-STD-002, Category 3, Test A
<b>Lead Bend</b>	MIL-STD-750: Method 2036, Condition E

**Dimensions — TO-220AB (L-Package) — Isolated Mounting Tab**



Dimension	Inches		Millimeters	
	Min	Max	Min	Max
A	0.380	0.420	9.65	10.67
B	0.105	0.115	2.67	2.92
C	0.230	0.250	5.84	6.35
D	0.590	0.620	14.99	15.75
E	0.142	0.147	3.61	3.73
F	0.110	0.130	2.79	3.30
G	0.540	0.575	13.72	14.61
H	0.025	0.035	0.64	0.89
J	0.195	0.205	4.95	5.21
K	0.095	0.105	2.41	2.67
L	0.060	0.075	1.52	1.91
M	0.085	0.095	2.16	2.41
N	0.018	0.024	0.46	0.61
O	0.178	0.188	4.52	4.78
P	0.045	0.060	1.14	1.52
R	0.038	0.048	0.97	1.22

4/6/8/10/15 A QUADRACS

**Product Selector**

Part Number	Voltage				Type	Package
	400V	600V	800V	1000V		
Qxx04LT	X	X			Quadrac	TO-220L
Qxx06LT	X	X			Quadrac	TO-220L
Qxx06LTH	X	X			Alternistor Quadrac	TO-220L
Qxx08LT	X	X			Quadrac	TO-220L
Qxx08LTH	X	X			Alternistor Quadrac	TO-220L
Qxx10LT	X	X			Quadrac	TO-220L
Qxx10LTH	X	X			Alternistor Quadrac	TO-220L
Qxx15LT	X	X			Quadrac	TO-220L
Qxx15LTH	X	X			Alternistor Quadrac	TO-220L

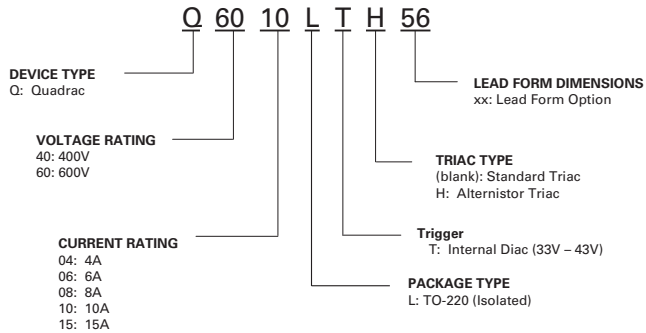
Note: xx = Voltage

**Packing Options**

Part Number	Marking	Weight	Packing Mode	Base Quantity
Qxx04LT	Qxx04LT	2.2 g	Bulk	500
Qxx04LTTP	Qxx04LT	2.2 g	Tube	500
Qxx06LT	Qxx06LT	2.2 g	Bulk	500
Qxx06LTTP	Qxx06LT	2.2 g	Tube	500
Qxx06LTH	Qxx06LTH	2.2 g	Bulk	500
Qxx06LTHTP	Qxx06LTH	2.2 g	Tube	500
Qxx08LT	Qxx08LT	2.2 g	Bulk	500
Qxx08LTTP	Qxx08LT	2.2 g	Tube	500
Qxx08LTH	Qxx08LTH	2.2 g	Bulk	500
Qxx08LTHTP	Qxx08LTH	2.2 g	Tube	500
Qxx10LT	Qxx10LT	2.2 g	Bulk	500
Qxx10LTTP	Qxx10LT	2.2 g	Tube	500
Qxx10LTH	Qxx10LTH	2.2 g	Bulk	500
Qxx10LTHTP	Qxx10LTH	2.2 g	Tube	500
Qxx15LT	Qxx15LT	2.2 g	Bulk	500
Qxx15LTTP	Qxx15LT	2.2 g	Tube	500
Qxx15LTH	Qxx15LTH	2.2 g	Bulk	500
Qxx15LTHTP	Qxx15LTH	2.2 g	Tube	500

Note: xx = Voltage

**Part Numbering System**



**Part Marking System**

**TO-220AB (L Package)**

